

Revive Collection

Topmount 50/50 Double Bowl 

Model REV-3322DT-6-3 3 holes

REV-3322DT-6-4 4 holes



FEATURES

REV-3322DT-6

- Premium grade T-304 stainless steel
- 6" depth
- 23 gauge
- 3 or 4 holes
- StoneShield undercoating over Sound Deadening pad
- Fits 36" sink base
- 3-1/2" drain opening
- Supplied with fasteners and instructions
- Complies with ASME A112.19.3-2008, cUPC®
- Lifetime Limited Warranty



ASME A112.19.3-2008

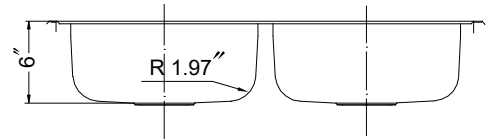
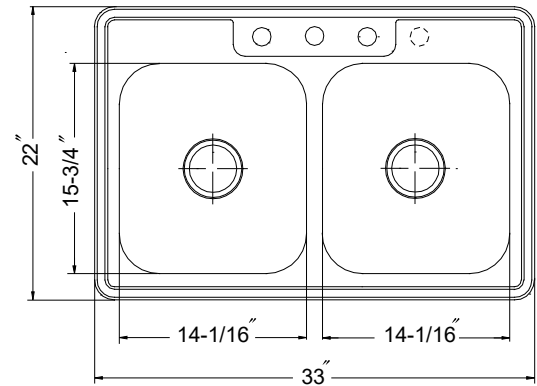

OPTIONAL ACCESSORIES

Bottom Grid: SWG-1214

Cutting Board : CUT-1517

Strainer: BAS-2000-SS

OVERALL DIMENSIONS	EACH BOWL	CUTOUT SIZE	PACKAGING*	WEIGHT*
33" x 22"	14-1/16" x 15-3/4"	32-1/4" x 21-1/4"	1/16/36 pcs.	12/230/350 lbs.

*Standard packaging: Single boxed /Pallet of single boxed/Pallet of bulk pack.
All dimensions are in inches. Specifications subject to change without notice.

Project/Job name _____

Architect/Engineer _____

Contractor _____

Model _____ Q'ty _____

Notes _____

Installation profile

